

Digital Still Camera

Operating Instructions

Before operating the unit, please read this manual thoroughly, and retain it for future reference.

Owner's Record

The model and serial numbers are located on the bottom. Record the serial number in the space provided below. Refer to these numbers whenever you call upon your Sony dealer regarding this product.

Model No. MVC-FD95

Serial No. _____

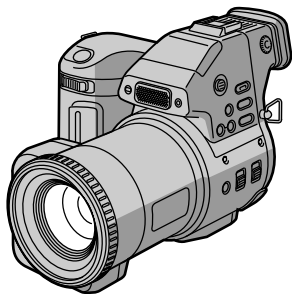

MVC-FD95

Digital Mavica



WARNING

To prevent fire or shock hazard, do not expose the unit to rain or moisture.

For the Customers in the U.S.A.

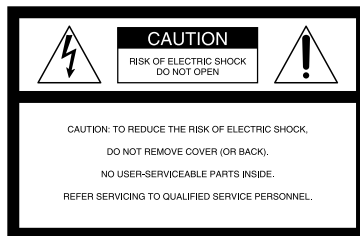

This symbol is intended to alert the user to the presence of uninsulated “dangerous voltage” within the product’s enclosure that may be of sufficient magnitude to constitute a risk of electric shock to persons.



This symbol is intended to alert the user to the presence of important operating and maintenance (servicing) instructions in the literature accompanying the appliance.

If you have any questions about this product, you may call: Sony Customer Information Center 1-800-222-SONY (7669) or write to: Sony Customer Information Center 1 Sony Drive, Mail Drop #T1-11, Park Ridge, NJ07656

CAUTION

You are cautioned that any changes or modifications not expressly approved in this manual could void your authority to operate this equipment.

Note:

This equipment has been tested and found to comply with the limits for a Class B digital device, pursuant to Part 15 of the FCC Rules. These limits are designed to provide reasonable protection against harmful interference in a residential installation. This equipment generates, uses, and can radiate radio frequency energy and, if not installed and used in accordance with the instructions, may cause harmful interference to radio communications. However, there is no guarantee that interference will not occur in a particular installation. If this equipment does cause harmful interference to radio or television reception, which can be determined by turning the equipment off and on, the user is encouraged to try to correct the interference by one or more of the following measures:

- Reorient or relocate the receiving antenna.
- Increase the separation between the equipment and receiver.
- Connect the equipment into an outlet on a circuit different from that to which the receiver is connected.
- Consult the dealer or an experienced radio/TV technician for help.

For the Customers in the U.S.A. and Canada

DISPOSAL OF LITHIUM ION BATTERY.

LITHIUM ION BATTERY.

DISPOSE OF PROPERLY.

You can return your unwanted lithium ion batteries to your nearest Sony Service Center or Factory Service Center.

Note:

In some areas the disposal of lithium ion batteries in household or business trash may be prohibited.

For the Sony Service Center nearest you call 1-800-222-SONY (United States only)
For the Sony Factory Service Center nearest you call 416-499-SONY (Canada only)

Caution:

Do not handle damaged or leaking lithium ion battery.



For the Customers in Canada

CAUTION

TO PREVENT ELECTRIC SHOCK, DO NOT USE THIS POLARIZED AC PLUG WITH AN EXTENSION CORD, RECEPTACLE OR OTHER OUTLET UNLESS THE BLADES CAN BE FULLY INSERTED TO PREVENT BLADE EXPOSURE.

NOTICE FOR THE CUSTOMERS IN THE UNITED KINGDOM

A moulded plug complying with BS 1363 is fitted to this equipment for your safety and convenience.

Should the fuse in the plug supplied need to be replaced, a 5 AMP fuse approved by ASTA or BSI to BS 1362, (i.e. marked with  or  mark) must be used.

If the plug supplied with this equipment has a detachable fuse cover, be sure to attach the fuse cover after you change the fuse. Never use the plug without the fuse cover. If you should lose the fuse cover, please contact your nearest Sony service station.

For the Customers in Germany

Directive: EMC Directive 89/336/EEC.92/31/EEC

This equipment complies with the EMC regulations when used under the following circumstances:

- Residential area
- Business district
- Light-industry district

(This equipment complies with the EMC standard regulations EN55022 Class B.)

Attention

The electromagnetic fields at the specific frequencies may influence the picture and sound of this camera.

Be sure to read the following before using your camera

Operating instructions

Before operating the unit, please read this manual thoroughly, and retain it for future reference.

Before you start reading this manual and operating the unit, check the model number. As you read through this manual, buttons and settings on the camera are shown in capital letters.
e.g. Press DISPLAY.

Trial recording

Before you record one-time events, you may want to make a trial recording to make sure that the camera is working correctly.

No compensation for contents of the recording

Contents of the recording cannot be compensated for if recording or playback is not possible due to a malfunction of your camera, etc.

Precaution on copyright

Television programs, films, video tapes, and other materials may be copyrighted. Unauthorized recording of such materials may be contrary to the provision of the copyright laws.

Do not shake or strike the camera

In addition to malfunctions and inability to record images, this may render the floppy disks unusable or image data breakdown, damage or loss may occur.

LCD screen, finder, and lens

- The LCD screen and finder are manufactured using high-precision technology. However, there may be some tiny black points and/or bright points (red, blue or green in color) that constantly appear on the LCD screen or on the finder. These points are normal in the manufacturing process and do not affect the recording in any way. Over 99.99% of the pixels are operational for effective use.
- Be careful when placing the camera near a window or outdoors. Exposing the LCD screen or the lens to direct sunlight for long periods may cause malfunctions.

Do not get the camera wet

When taking pictures outdoors in the rain or under similar conditions, be careful not to get the camera wet. If moisture condensation occurs, refer to page 55 and follow the instructions on how to remove it before using the camera.

Back up recommendation

To avoid the potential risk of data loss, always copy (back up) data to a disk.

Table of contents

Getting started

Identifying the parts	6
Preparing the power supply	8
Setting the date and time	12
Inserting a floppy disk	14

Basic operations

► Recording

Recording still images	15
Recording moving images	21

► Playback

Playing back still images	22
Playing back moving images	23
Viewing images using a personal computer	25
Image file storage destinations and image file names	27

Advanced operations

Before performing advanced operations

How to use the PLAY/STILL/ MOVIE selector	29
How to use the control button	29
How to change the menu settings	31

► Various recording

Setting the image size (IMAGE SIZE)	36
Recording still images for e-mail (E-MAIL)	37
Adding audio files to still images (VOICE)	37
Recording text documents (TEXT)	38
Recording images in macro	38
Focusing manually	39
Using the PROGRAM AE function	40

Using the Spot light – metering function	41
Adjusting the exposure (EXPOSURE)	41
Adjusting the white balance (WHITE BALANCE)	42
Recording the date and time on the still image (DATE/TIME)	43
Enjoying picture effects (PICTURE EFFECT)	43

► Various playback

Playing back six images at once (INDEX)	44
Enlarging a part of the still image (Zoom and trimming)	45
Playing back the still images in order (SLIDE SHOW)	46
Viewing images on a TV screen	47

► Editing

Preventing accidental erasure (PROTECT)	48
Deleting images (DELETE)	49
Changing the recorded still image size (RESIZE)	50
Copying images (COPY)	50
Copying all the information on your floppy disk (DISK COPY)	52
Selecting still images to print (PRINT MARK)	53
Format	54



Additional information

Precautions	55
Using your camera abroad	57
Troubleshooting	58
Warning and notice messages	61
Self-diagnosis display	63
Specifications	64
LCD screen/finder indicators	65
Index	67

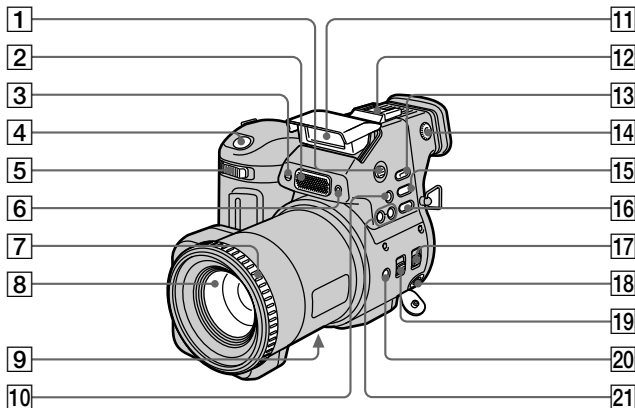

Identifying the parts

See the pages in parentheses for details of operation.

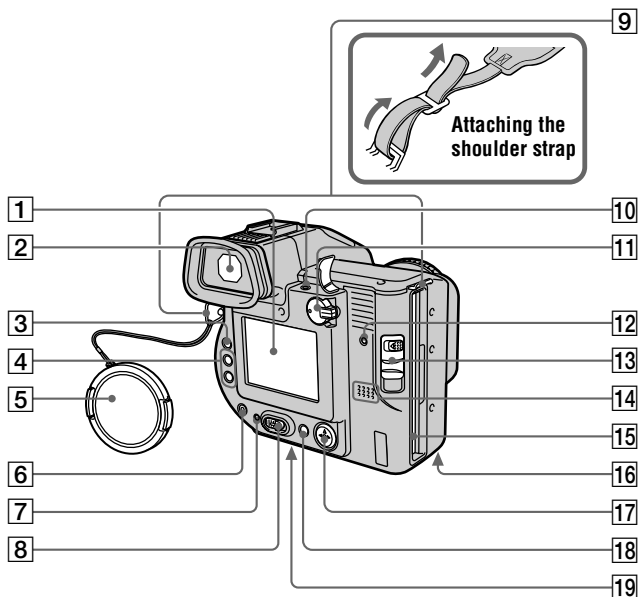

- | | |
|--|---|
| 1 OPEN (FLASH) button (19) | 12 Accessory shoe |
| 2 Built-in microphone
Do not touch while recording. | 13 SPOT METER button (41) |
| 3 Self-timer lamp (19) | 14 Finder adjustment dial (16) |
| 4 Shutter button (15, 21) | 15 WHITE BALANCE button (42) |
| 5 Zoom lever (17) | 16 PROGRAM AE button (40) |
| 6 Photocell window for flash
Do not block while recording. | 17 STEADY SHOT ON/OFF switch (18) |
| 7 Focus ring (39) | 18 AUDIO (MONO) /VIDEO OUT jack (47)
Audio output is monaural. |
| 8 Lens | 19 FOCUS AUTO/MANUAL switch (38, 39) |
| 9 DC IN cover/DC IN jack (9, 11) | 20  (Macro) button (38) |
| 10  (One-push white balance) button (42) | 21 PROGRAM AE +/- buttons (40) |
| 11 Flash (19) | |



- | | |
|--|---|
| 1 LCD screen | 13 DISK EJECT lever (14) |
| 2 Finder (16) | 14 Speaker |
| 3 LCD ON/OFF switch (16) | 15 Floppy disk slot (14) |
| 4 VOL +/- buttons (24) | 16 Battery cover/PUSH button (bottom surface) (8) |
| 5 Lens cap (supplied) | 17 Control button (29) |
| 6  (Flash) button (19) | 18 DISPLAY button (18) |
| 7 ON/CHG (Charge) lamp (9) | 19 Tripod receptacle (bottom surface) |
| 8 POWER switch (12) | |
| 9 Hooks for strap | |
| 10  (External flash) jack | |
| 11 PLAY/STILL/MOVIE selector (29) | |
| 12 ACCESS lamp (16) | |

Use a tripod with a screw length of less than 6.5 mm (7/32 inch). You will be unable to firmly secure the camera to tripods having longer screws, and may damage the camera.

Preparing the power supply

Installing the battery pack

Your camera operates only with the NP-F330 (supplied)/F550 (not supplied) “InfoLITHIUM” battery pack* (L series).

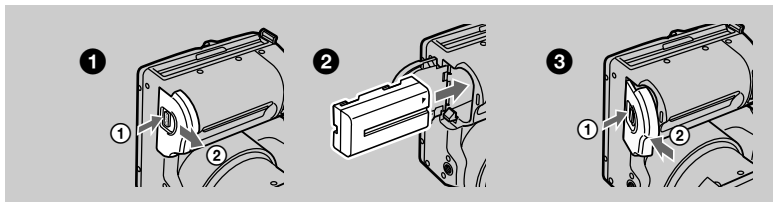

- 1 Open the battery cover.**
Slide the battery cover in the direction of the arrow while pressing the PUSH button.
- 2 Install the battery pack.**
Insert the battery pack with the ▲ mark facing toward the battery compartment as illustrated.
- 3 Close the battery cover.**

To remove the battery pack

Open the battery cover. Slide the battery eject lever rightward, and remove the battery pack.

Be careful not to drop the battery pack when removing it.

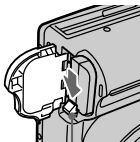

Battery eject lever

* What is “InfoLITHIUM”?

“InfoLITHIUM” is a lithium ion battery pack which can exchange information such as battery consumption with compatible video equipment. “InfoLITHIUM” L series battery packs have the  mark. “InfoLITHIUM” is a trademark of Sony Corporation.

Charging the battery pack

When the camera is turned on, you cannot charge the battery pack. Be sure to turn off the power of the camera.

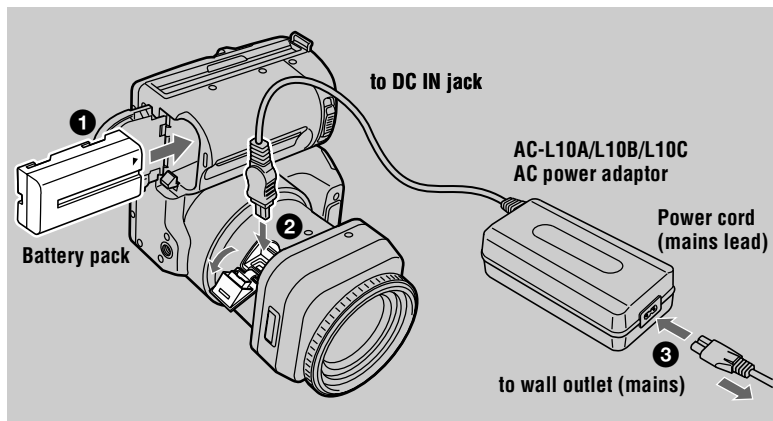

- 1** Insert the battery pack into your camera.
- 2** Open the DC IN cover and connect the DC connecting plug to the DC IN jack of your camera with the ▲ mark facing up.
- 3** Connect the power cord (mains lead) to the AC power adaptor and then to a wall outlet (mains).
The ON/CHG lamp (orange) below the LCD screen lights up when charging begins. When the ON/CHG lamp goes off, **normal charge** is completed. For **full charge**, which allows you to use the battery longer than usual, leave the battery pack inserted for about one hour after normal charge is completed.

Battery remaining indicator

The LCD screen or finder on the camera shows the remaining time for which you can still record or play back images.

This indication may not be entirely accurate depending on the conditions of use and the operating environment.

Auto power-off function

If you do not operate the camera for about three minutes during recording, the camera turns off automatically to prevent wearing down the battery pack. To use the camera again, slide the POWER switch to the right to turn on the camera again.

Charging time

Battery pack	Full charge (min.)	Normal charge (min.)
NP-F330 (supplied)	Approx. 150	Approx. 90
NP-F550	Approx. 210	Approx. 150

Approximate time to charge a completely discharged battery pack using the AC-L10A/L10B/L10C AC power adaptor. (Lower temperatures require a longer charging time.)

Battery life and number of images that can be recorded/played back

STILL mode recording/playback

	NP-F330 (supplied)		NP-F550	
	Battery life (min.)	Number of images	Battery life (min.)	Number of images
Continuous recording*	Approx. 65 (60)	Approx. 650 (550)	Approx. 150 (130)	Approx. 1600 (1300)
Continuous playback**	Approx. 80 (75)	Approx. 2200 (2000)	Approx. 170 (150)	Approx. 4800 (4200)

Approximate battery life and number of images that can be recorded/played back with a fully charged battery pack at a temperature of 25 °C (77 °F), 640 480 image size and in NORMAL recording mode. Numbers in parentheses indicate the time when you use a normally charged battery pack.

* Recording at about 5-second intervals

** Playing back single images continuously at about 2-second intervals

MOVIE mode recording

	NP-F330 (supplied)		NP-F550	
	Battery life (min.)	Number of images	Battery life (min.)	Number of images
Continuous recording	Approx. 70 (60)	Approx. 50 (40)	Approx. 160 (140)	Approx. 120 (100)

Approximate time that can be recorded with a fully charged battery pack at a temperature of 25°C (77°F) and 160×112 image size. Numbers in parentheses indicate the time when you use a normally charged battery pack.

Notes

- The battery life and number of images will be decreased when using at low temperature, using the flash, turning the power on/off frequently, or using the zoom.
- The capacity of the floppy disk is limited. The above figures are a guide when you continuously record/play back by replacing the floppy disk.
- If sufficient battery remaining time is indicated but the power runs out soon, fully charge the battery so that the correct battery remaining time appears.
- Do not short the DC plug of the AC power adaptor with a metallic object, as this may cause malfunction.
- Do not expose the battery pack to water.

Using the AC power adaptor

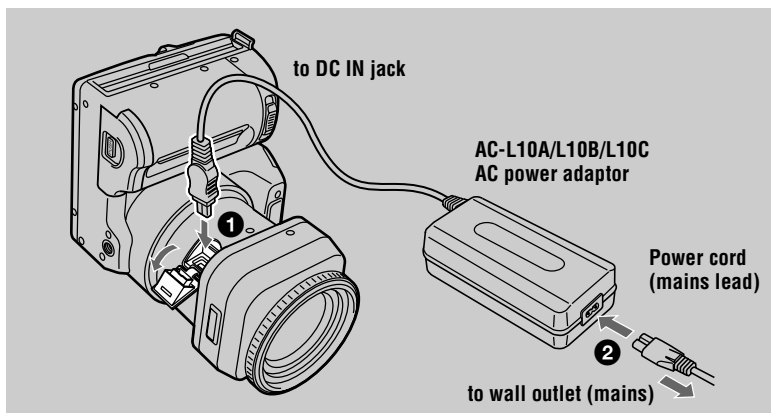

- 1** Open the DC IN cover and connect the DC connecting plug to the DC IN jack of your camera with the ▲ mark facing up.
- 2** Connect the power cord (mains lead) to the AC power adaptor and then to a wall outlet (mains).

Using a car battery

Use Sony DC adaptor/charger.

Setting the date and time

When you first use your camera, set the date and time. If these are not set, the CLOCK SET screen appears whenever you turn on your camera for recording.

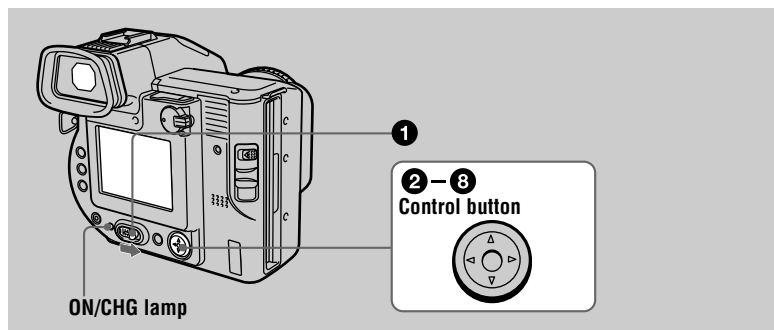

- 1** Slide the **POWER** switch to the right to turn on the power.
The ON/CHG (green) lamp lights up.

- 2** Press **▲** on the control button.
The menu bar appears on the LCD screen or on the finder.

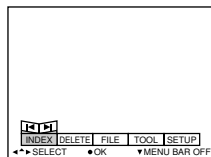

- 3** Select **[SETUP]** with **▶** on the control button, then press the center **●**.

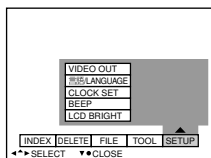

- 4** Select **[CLOCK SET]** with **▲/▼** on the control button, then press the center **●**.

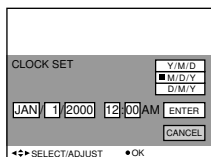
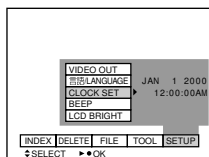

- 5** Select the desired date display format with ▲/▼ on the control button, then press the center ●.

Select from [Y/M/D] (year/month/day), [M/D/Y] (month/day/year), or [D/M/Y] (day/month/year).

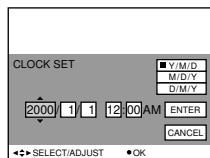

- 6** Select the year, month, day, hour or minute item you want to set with ◀/▶ on the control button.

The item to be set is indicated with ▲/▼.

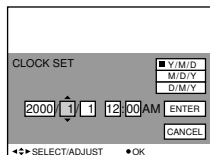

- 7** Set the numeric value with ▲/▼ on the control button, then press the center ● to enter it.

After entering the number, ▲/▼ moves to the next item. If you selected [D/M/Y] in step 5, set the time on a 24-hour cycle.

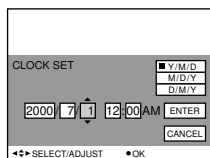

- 8** Select [ENTER] with ▶ on the control button, then press the center ● at the desired moment to begin clock movement.

The date and time are entered.

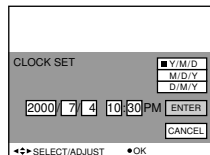

To cancel the date and time setting

Select [CANCEL] with ▲/▼/◀/▶ on the control button, then press the center ●.

Inserting a floppy disk

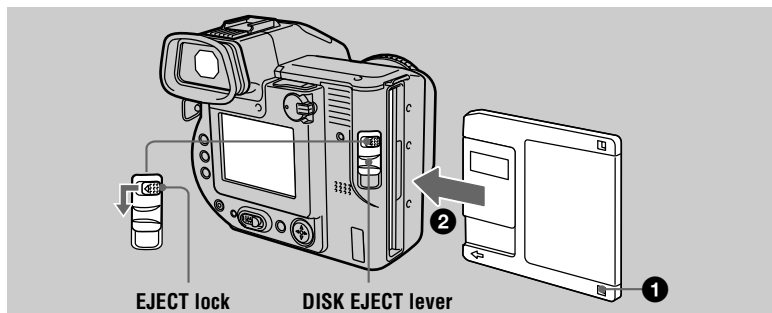

- 1 Check that the write protect tab is set to the recordable position for recording.

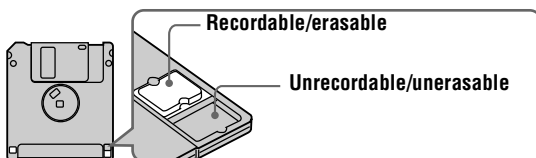

- 2 Insert the floppy disk until it clicks.

Usable floppy disks

- Size: 3.5 inch
- Type: 2HD
- Capacity: 1.44 MB
- Format: MS-DOS format (512 bytes 18 sectors)

You can use the "Memory Stick"* (not supplied) with inserting it into the MSAC-FD2M Floppy Disk Adaptor for Memory Stick (not supplied), other than floppy disks mentioned above.

* "Memory Stick" and  are trademarks of Sony Corporation.

Removing the floppy disk

While sliding the EJECT lock to the left, slide down the DISK EJECT lever.

Recording still images

Still images are recorded in JPEG format.

To record still images, slide the POWER switch to the right to turn on the power and insert a floppy disk.

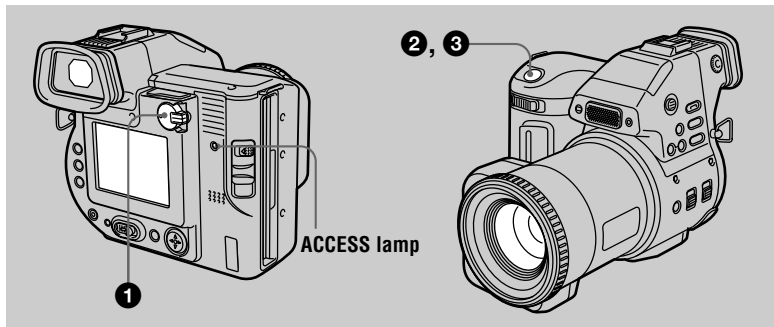

1 Set the PLAY/STILL/MOVIE selector to STILL.

2 Press and hold the shutter button halfway down and check the image. While the AE lock indicator ● (green) is flashing, the image is frozen, however, the image is not yet recorded. When the camera finishes the automatic adjustments*, the AE lock indicator ● lights up and the camera is ready for recording. To cancel the recording, release the shutter button.

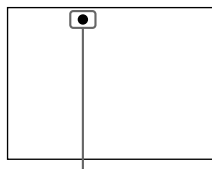

AE lock indicator

3 Press the shutter button fully down. The shutter clicks and the image is recorded on the floppy disk.

* The exposure and focus are automatically adjusted. The focus is not automatically adjusted when the camera is in manual focus mode.

For the number of images you can record on a floppy disk

See page 36.

Notes

- When recording bright subjects, the color of the LCD screen or the finder may change after the AE is locked, however, this will not affect the recorded image.
- While the image is being recorded on a floppy disk, the ACCESS lamp lights. When this lamp is lit, do not shake or strike the camera. Also, do not turn the power off, or not remove the battery pack/floppy disk. Otherwise, an image data breakdown may occur and the floppy disk may become unusable.
- When using a “Memory Stick,” writing and reading images take about twice times than using a floppy disk.

Recording images with the finder

Turn the finder adjustment dial until the image appears clearly within the finder, then record the image.

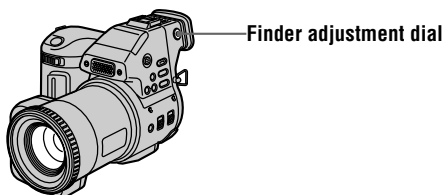

Note

The finder display is automatically turned off when your face is not near the finder.

To turn off the LCD screen

Set the LCD ON/OFF switch to OFF.

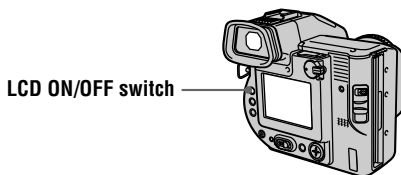

Notes

- You cannot turn off the LCD screen when [DEMO] is set to [ON] in the menu setting.
- When the LCD ON/OFF switch is set to OFF and the finder display is turned off, you can only operate the LCD ON/OFF switch, POWER switch, and the PLAY/ STILL/MOVIE selector.

Adjusting the brightness of the LCD screen

Adjust the brightness with the [LCD BRIGHT] item in the menu settings (page 35). This adjustment does not affect the brightness of the images recorded on the floppy disk.

Checking the last recorded image (Review)

Clear the menu bar (page 30), and press ◀ on the control button. To return to the normal recording mode, press lightly on the shutter button or select [RETURN] with ◀/▶ on the control button and then press the center ●. To delete the image, select [DELETE] on the review screen with ◀/▶ on the control button, then press the center ●. And select [OK] with ▲ on the control button, then press the center ●.

Using the zoom feature

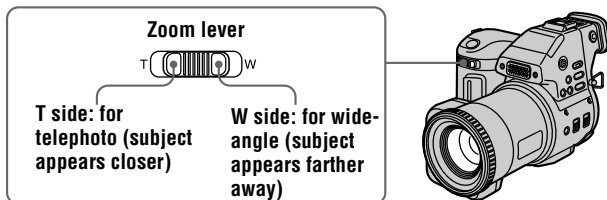

If you cannot get a sharp focus on a close subject

Slide the zoom lever to the W side and move closer to the subject until the focus is sharp.

Minimum focal distance to the subject

W side: About 25 cm (9 7/8 inches) or more

T side: About 80 cm (31 1/2 inches) or more

To record even closer subjects, see page 38.

Digital zoom function

This camera has a digital zoom function.

Digital zoom enlarges the image by digital processing, and it starts to function when the zoom exceeds 10 .

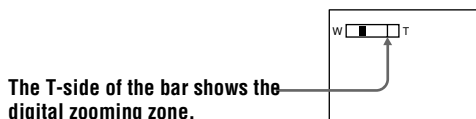

Using digital zoom

- The maximum zoom magnification is 20 .
- Digital zooming deteriorates the picture quality. When digital zoom is not necessary, set [DIGITAL ZOOM] to [OFF] in the menu settings (page 34).

Note

Digital zoom does not work for moving images.

Activating the SteadyShot function

When the SteadyShot function is working, the camera compensates for camera-shake.

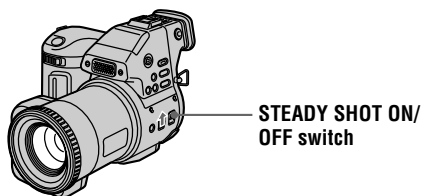

Set the STEADY SHOT ON/OFF switch to ON. The “” (SteadyShot) indicator appears on the LCD screen or on the finder.

Notes

- The SteadyShot function will not correct excessive camera-shake.
- If you use a wide conversion lens (not supplied), this lens may influence the SteadyShot function.

LCD screen or finder indicators during recording

Press DISPLAY to turn on/off the indicators on the LCD screen or on the finder. See page 65 for a detailed description of the indicators.

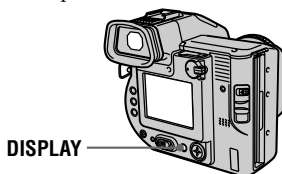







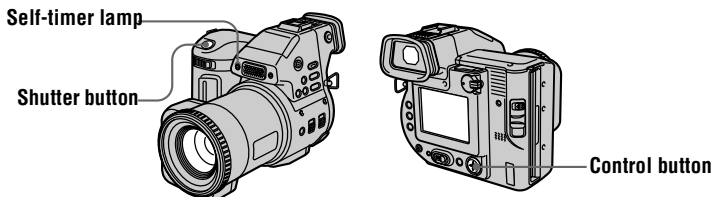

Notes

- You cannot turn off the  (self-timer) indicator and some of the indicators used in advanced operations.
- The indicators on the LCD screen or on the finder are not recorded.

Using the self-timer

When you use the self-timer function, the subject is recorded 10 seconds after you press the shutter button.





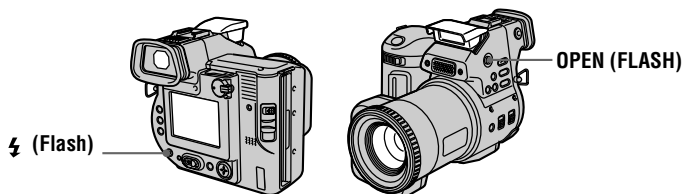

Select  on the LCD screen with /// on the control button, then press the center . The  (self-timer) indicator appears on the LCD screen or on the finder, and the subject is recorded 10 seconds after you press the shutter button. The self-timer lamp flashes after you press the shutter button until the image is recorded.

Recording images with the flash

Press OPEN (FLASH) to pop up the flash. The initial setting is AUTO (no indication). In this mode, the flash automatically strobes when the surroundings become dark. When you change the flash mode, press  (Flash) repeatedly so that the flash mode indicator appears on the LCD screen or on the finder. This setting can be set only when the flash is popped up.



Each time you press the button, the indicator changes as follows.
(No indication) →  →  →  → (No indication)

 Auto red-eye reduction : The flash preparatively strobes before recording to reduce the red-eye phenomenon.

 Forced flash : The flash strobes regardless of the surrounding brightness.

 No flash : The flash does not strobe.

You can change the amount of the flash light with [FLASH LEVEL] in the menu settings (page 34).

Notes

- The recommended shooting distance is 0.6 to 2.5 m (23 5/8 inches to 8 1/3 feet).
- Attaching a conversion lens (not supplied) may block the light from the flash and the recorded image may be eclipsed.
- You cannot use the built-in flash and an external strobe at the same time.
- The  indicator appears when the flash is not popped up under situations that you should use the flash.
- Auto red-eye reduction may not produce the desired red-eye reduction effects depending on individual differences, the distance to the subject, if the subject does not see the pre-strobe, or other conditions. In addition, red-eye reduction effects are also difficult to obtain if you select a slow shutter speed in shutter priority mode of the PROGRAM AE function.
- The flash effect is not obtained easily when you use forced flash in a bright location.

Recording moving images

Moving images with audio are recorded in MPEG format.

To record moving images, slide the POWER switch to the right to turn on the power and insert a floppy disk.

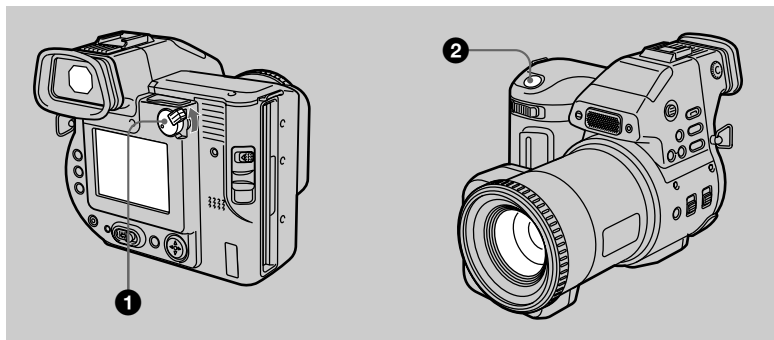

1 Set the PLAY/STILL/MOVIE selector to MOVIE.

2 Press the shutter button fully down.

“REC” appears on the LCD screen or on the finder, and the image and sound are recorded on the floppy disk.

If you press the shutter button momentarily

The image and sound are recorded for 5 seconds. The recording time can be set to 10 or 15 seconds with [REC TIME SET] in the menu settings (page 33).

If you hold the shutter button down

The image and sound are recorded while the shutter button is held down for up to 60 seconds. However, when [IMAGE SIZE] in the menu settings is set to [320×240], the maximum recording time is 15 seconds (page 36).

Adjusting the brightness of the LCD screen, zooming or using the self-timer

See page 16 to 19.

LCD screen or finder indicators during recording

Press DISPLAY to turn on/off the indicators on the LCD screen or on the finder. These indicators are not recorded. See page 65 for a detailed description of the indicators.

Playing back still images

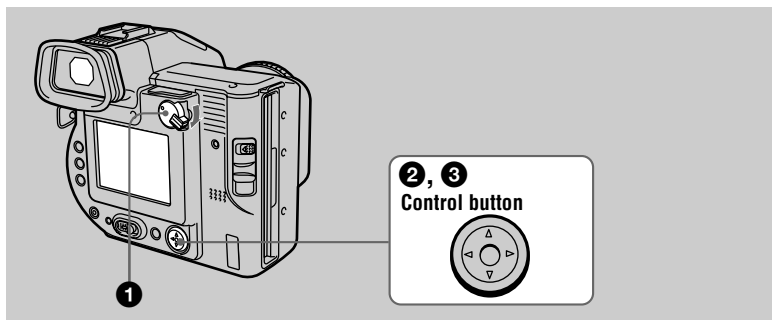

- 1** Set the **PLAY/STILL/MOVIE** selector to **PLAY**.
The last recorded image (still or moving) appears on the LCD screen or on the finder.
- 2** Press **▲** on the control button to display the menu bar on the LCD screen or on the finder.
- 3** Select the desired still image with the control button.
Press **▲/▼/◀/▶** on the control button to select **◀/▶** on the LCD screen or on the finder, then press **◀/▶**.
◀: To display the preceding image.
▶: To display the next image.

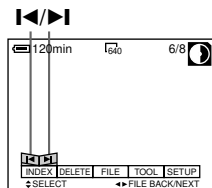

When the menu bar is not displayed

You can directly select and play back the image with **◀/▶** on the control button.

Notes

- You might not be able to correctly play back images recorded with this camera on other equipment.
- You may not be able to play back images whose image sizes are larger than the maximum image size that can be used with this camera for recording.

LCD screen or finder indicators during still image playback

Press **DISPLAY** to turn on/off the indicators on the LCD screen or on the finder. See page 66 for a detailed description of the indicators.

Playing back moving images

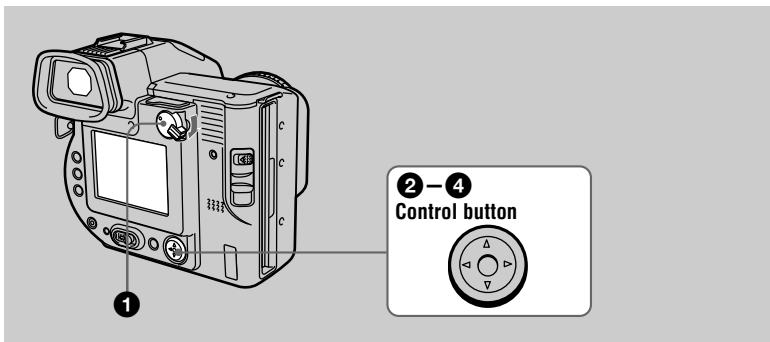

1 Set the PLAY/STILL/MOVIE selector to PLAY.
The last recorded image (still or moving) appears on the LCD screen or on the finder.

2 Press ▲ on the control button to display the menu bar on the LCD screen or on the finder.

3 Select the desired moving image with the control button.
Moving images are displayed one size smaller than still images.
Press ▲/▼/◀/▶ on the control button to select ◀/▶ on the LCD screen or on the finder, then press ◀/▶.
◀: To display the preceding image.
▶: To display the next image.

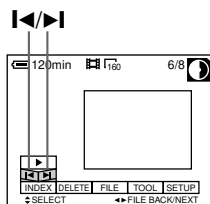

4 Select the ► (playback) button on the LCD screen or on the finder with ▲ on the control button, then press the center ●.
The moving image and sound are played back.
During playback, ► (playback) changes to || (pause).

► (playback)/
|| (pause) button

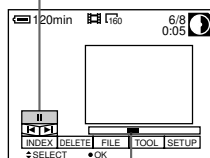

Playback bar

To pause playback

Select **II** (pause) on the LCD screen or on the finder with **▲/▼/◀/▶** on the control button, then press the center **●**.

When the menu bar is not displayed

You can directly select the image with **◀/▶** on the control button, and play back the image and sound by pressing the center **●**. When you press the center **●** during playback, playback is paused.

Adjusting the volume

Press VOL +/- to adjust the volume.

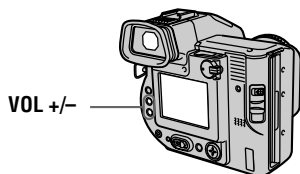

LCD screen or finder indicators during moving image playback

Press DISPLAY to turn on/off the indicators on the LCD screen or on the finder. See page 66 for a detailed description of the indicators.

Viewing images using a personal computer

You can view data with your camera on a personal computer and attach it to e-mail. This section describes the general method for viewing images on a personal computer. Be sure to also see the operation manuals for your personal computer and application software.

Note

Data recorded with your camera is stored in the following formats. Make sure that applications that support these file formats are installed on your personal computer.

- Still image (except TEXT mode) : JPEG format
- Moving image/Voice memo: MPEG format
- Still image in TEXT mode : GIF format.

Recommended OS/applications

OS

Windows 3.1, Windows 95, Windows 98, Windows 98SE, Windows NT 3.51, Windows NT 4.0

Applications

Microsoft Internet Explorer 4.0 or higher, Netscape Navigator, etc.

To display the image list, double-click [Mavica.htm] in the floppy disk used with this camera as a medium for recording if you have installed a browser such as Microsoft Internet Explorer on your personal computer.



Notes

- To play back an MPEG file, install ActiveMovie (DirectShow).
- You cannot play back an MPEG file with Windows 3.1.
- For Macintosh, you can use the floppy disk recorded with this camera using PC Exchange with Mac OS system 7.5 or higher. A viewing application for Macintosh is also necessary for viewing images. To play back an MPEG file, install QuickTime 3.0 or higher.
- When using the MSAC-FD2M Floppy Disk Adaptor for Memory Stick, the recommended OS is Windows 98, Windows 95, Windows NT 4.0 or Mac OS 7.6 - 8.6.

Viewing images

For Windows 98 users

1 Start up your personal computer and insert the floppy disk into the disk drive of your personal computer.

2 Open [ My computer] and double click [ 3 1/2 Floppy (A:)].

3 Double-click the desired data file.

Copying moving image files and audio files to the hard disk of your personal computer before viewing is recommended. If you play back the file directly from the floppy disk, the image and sound may break off.

- Windows and Windows NT, ActiveMovie, DirectShow are either registered trademarks or trademarks of Microsoft Corporation in the United States and/or other countries.
 - Macintosh and Mac OS, QuickTime are trademarks of Apple Computer, Inc.
 - All other product names mentioned herein may be the trademarks or registered trademarks of their respective companies.
- Furthermore, “™” and “®” are not mentioned in each case in this manual.

Image file storage destinations and image file names

Image files recorded with your camera are grouped in folders by recording mode. Images in a floppy disk and ones in a “Memory Stick” have different file names. The meanings of the file names are as follows.

When using floppy disks

□□□ stands for any number within the range from 001 to 999.

△ stands for one of the following characters below.

S: Still image file recorded at 640×480 size

F: Still image file of more than 640×480 size

V: Moving image file recorded at 160×112 size

W: Moving image file recorded at 320×240 size

For Windows 98 users (The drive recognizing the floppy disk is [A].)

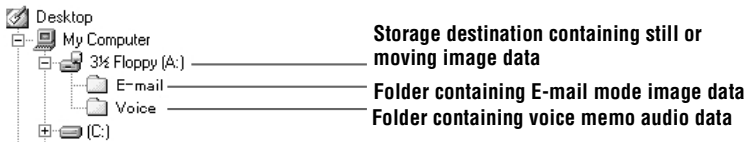

Location	File	Meaning
3 1/2 Floppy (A:)	MVC-□□□△.JPG	<ul style="list-style-type: none"> • Still image file recorded normally • Still image file recorded in E-MAIL mode (page 37) • Still image file recorded in VOICE mode (page 37)
	MVC-□□□△.411	<ul style="list-style-type: none"> • INDEX display file This file can only be played back on your camera.
	MVC-□□□△.MPG	<ul style="list-style-type: none"> • Moving image file
	MVC-□□□T.GIF	<ul style="list-style-type: none"> • Still image file recorded in TEXT mode (page 38)
E-mail folder	MVC-□□□E.JPG	<ul style="list-style-type: none"> • Small-size image file recorded in E-MAIL mode (page 37)
Voice folder	MVC-□□□A.MPG	<ul style="list-style-type: none"> • Audio file recorded in VOICE mode (page 37)

The numerical portion of the following files are the same.

- An image file recorded in VOICE mode and its corresponding audio file
- An image file recorded in E-MAIL mode and its corresponding small-size image file
- INDEX display files cannot be played back on other equipment.

When using “Memory Stick”s

□□□□ stands for any number within the range from 0001 to 9999.

For Windows 98 users (The drive recognizing the Floppy Disk Adaptor for Memory Stick is [A].)

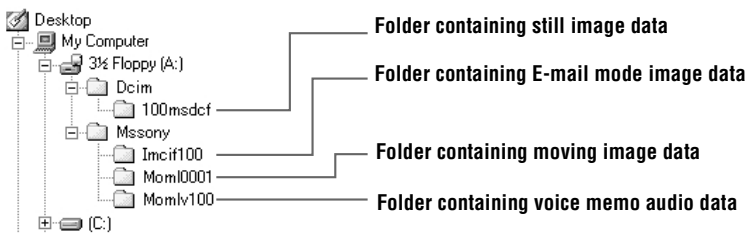

Folder	File	Meaning
100msdcf	DSC0□□□□.JPG	<ul style="list-style-type: none"> • Still image file recorded normally • Still image file recorded in E-MAIL mode (page 37) • Still image file recorded in VOICE mode (page 37)
	TXT0□□□□.GIF	<ul style="list-style-type: none"> • Still image file recorded in TEXT mode (page 38)
Imcif 100	DSC0□□□□.JPG	<ul style="list-style-type: none"> • Small-size image file recorded in E-MAIL mode (page 37)
Moml0001	MOV0□□□□.MPG	<ul style="list-style-type: none"> • Moving image file
Momlv100	DSC0□□□□.MPG	<ul style="list-style-type: none"> • Audio file recorded in VOICE mode (page 37)

The numerical portion of the following files are the same.

- An image file recorded in VOICE mode and its corresponding audio file
- An image file recorded in E-MAIL mode and its corresponding small-size image file

Before performing advanced operations

This section describes the basic control methods that are frequently used for “Advanced operations.”

How to use the PLAY/STILL/MOVIE selector

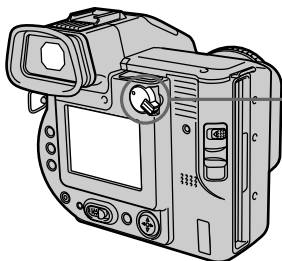

- PLAY:** To play back or edit images
- STILL:** To record still images and voice memos
- MOVIE:** To record moving images

How to use the control button

The control button is used to select the buttons, images and menus displayed on the LCD screen or on the finder of your camera and modify the settings. The operation methods that are frequently used for “Advanced Operations” are described below.

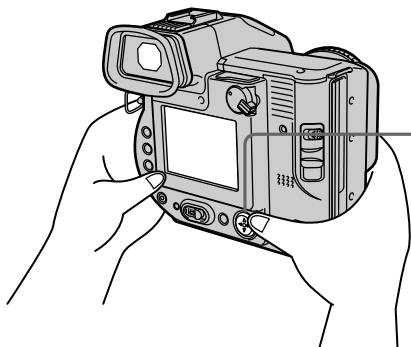

Select

Set (enter)



Turning on/off the operation buttons (menu bar) on the LCD screen or on the finder

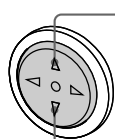

Press **▲** to display the menu bar on the LCD screen or on the finder.

Press **▼** to clear the menu bar from the LCD screen or on the finder.

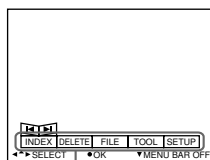

Menu bar

Note

You cannot clear the menu bar on the INDEX screen (page 44).

Selecting items or images on the LCD screen or on the finder

- 1 Press **▲/▼/◀/▶** on the control button to select the item you want to set or the image you want to display.

The color of the selected item or the frame of the selected image changes from blue to yellow.

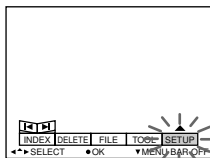

- 2 Press the center **●** to enter the item.

Repeat steps 1 and 2 to execute each function.

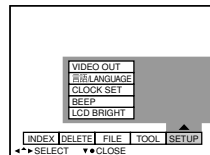

The “Advanced operations” section of this manual refers to selecting and entering items by the above procedure as “Select [item name].”

How to change the menu settings

Some of the advanced operations for your camera are executed by selecting menu items displayed on the LCD screen or on the finder with the control button.

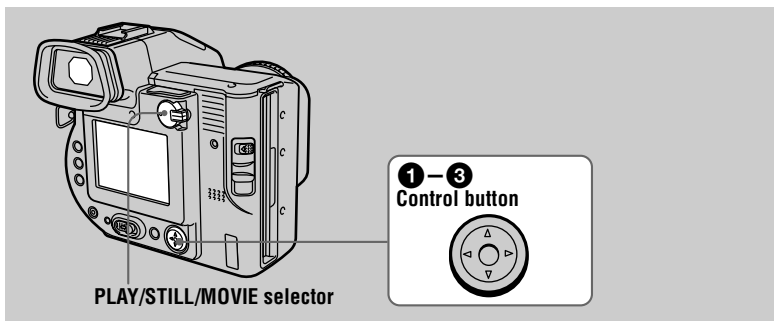

1 Press ▲ on the control button to display the menu bar.

The menu bar appears as follows according to the position of the PLAY/STILL/MOVIE selector.

MOVIE/STILL

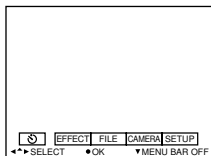

PLAY (single mode)

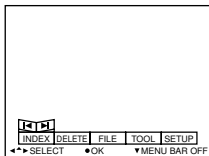

PLAY (INDEX mode)

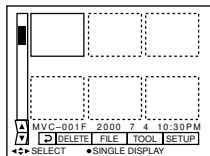

2 Select the desired item with ▲/▼/◀/▶ on the control button, then press the center ●.

The color of the selected item changes from blue to yellow, and when you press the center ●, the settings that can be set for its item are displayed.

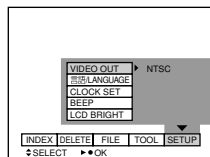

3 Select the desired setting with ▲/▼/◀/▶ on the control button, then press the center ●.

To cancel the setup

Press ▼ on the control button repeatedly until the LCD screen or on the finder returns to the menu bar display in step 1. To clear the menu bar, press ▼ again.

Menu settings

Menu items that can be modified differ depending on the position of the PLAY/STILL/MOVIE selector. The LCD screen or finder shows only the items you can operate at the moment. Initial settings are indicated with **■**.

(self-timer)

Records with the self-timer (page 19).

EFFECT

Item	Setting	Description	PLAY/STILL/ MOVIE selector
P. EFFECT	SOLARIZE B&W SEPIA NEG.ART ■ OFF	Sets the image special effects (page 43).	MOVIE STILL
DATE/ TIME	DAY & TIME DATE ■ OFF	Sets whether to insert the date and time into the image (page 43).	STILL

FILE

Item-1	Item-2	Setting	Description	PLAY/STILL/ MOVIE selector
DISK TOOL	FORMAT	OK	Formats a floppy disk (page 54).	MOVIE STILL PLAY
		CANCEL	Cancels formatting of a floppy disk.	
	DISK COPY	OK CANCEL	Copies all data stored in a floppy disk to another disk (page 52). Cancels the disk copy.	
CANCEL			Goes back to the [DISK TOOL] item.	

Item	Setting	Description	PLAY/STILL/ MOVIE selector
FILE NUMBER	SERIES ■ NORMAL	Assigns numbers to files in sequence even if the floppy disk is changed. Resets the file number that starts from 001 each time the floppy disk is changed.	MOVIE STILL

Item	Setting	Description	PLAY/STILL/ MOVIE selector
IMAGE SIZE	<input checked="" type="checkbox"/> 1600×1200 1600(3:2) 1600 (ECM) 1024×768 640×480	Selects the image size when recording still images.	STILL
	320×240 <input checked="" type="checkbox"/> 160×112	Selects the MPEG image size when recording moving images.	MOVIE
REC MODE	TEXT	Records a GIF file in black-and-white.	STILL
	VOICE	Records an audio file (with a still image) in addition to the JPEG file.	
	E-MAIL	Records a small-size (320 240) JPEG file in addition to the selected image size.	
	<input checked="" type="checkbox"/> NORMAL	Records a JPEG file in the selected image size.	
REC TIME SET	15 sec 10 sec <input checked="" type="checkbox"/> 5 sec	Selects the recording time for moving images.	MOVIE
SLIDE SHOW (Only in PLAY (single) mode)	INTERVAL	Sets the slide show interval. <input checked="" type="checkbox"/> 3 sec/5 sec/10 sec/30 sec/1 min	PLAY
	REPEAT	A slide show can be repeated for up to approx. 20 minutes. <input checked="" type="checkbox"/> ON/OFF	
	START	Starts the slide show.	
	CANCEL	Cancels the slide show settings or execution.	
PRINT MARK	—	Marks the images to be printed (page 53).	PLAY
PROTECT	—	Protects images against accidental erasure (page 48).	PLAY

CAMERA

Item	Setting	Description	PLAY/STILL/ MOVIE selector
DIGITAL ZOOM	■ ON OFF	Uses digital zoom. Does not use digital zoom.	STILL
SHARPNESS	+2 to -2	Adjusts the sharpness of the image. The  indicator appears (except when the setting is 0).	STILL
FLASH LEVEL	HIGH ■ NORMAL LOW	Makes the flash level higher than normal. Normal setting. Makes the flash level lower than normal.	STILL
EXPOSURE	+2.0EV to -2.0EV	Adjusts the exposure.	MOVIE STILL

TOOL

Item	Setting	Description	PLAY/STILL/ MOVIE selector
COPY	OK ■ CANCEL	Copies the images (page 50). Cancels copying of the image.	PLAY
RESIZE (Only in PLAY (single mode)	1600×1200 1024×768 640×480 ■ CANCEL	Changes the recorded image size (page 50).	PLAY

SETUP

Item	Setting	Description	PLAY/STILL/ MOVIE selector
DEMO	■ STBY/ON OFF	Displayed only when you use the AC power adaptor in MOVIE or STILL mode. When [ON] is selected, a demonstration will start if you do not operate your camera for about 10 minutes. To stop the demonstration, turn off your camera.	MOVIE STILL
VIDEO OUT	■ NTSC PAL	Sets the video output signal to NTSC mode (e.g., Japan, the USA). Sets the video output signal to PAL mode (e.g., Europe).	MOVIE STILL PLAY

Item	Setting	Description	PLAY/STILL/ MOVIE selector
言語 / LANGUAGE	日本語 /JPN ■ ENGLISH	Displays the menu items in Japanese. Displays the menu items in English.	MOVIE STILL PLAY
CLOCK SET	—	Sets the date and time. (page 12)	MOVIE STILL PLAY
BEEP	SHUTTER ■ ON OFF	Turns off the beep only. (The shutter sound is heard when you press the shutter button.) Turns on the beep/shutter sound (when you press the control button/shutter button). Turns off the beep/shutter sound.	MOVIE STILL PLAY
LCD BRIGHT	■■■■■■■■■■	Adjusts the LCD screen brightness using +/- on the LCD screen.	MOVIE STILL PLAY

INDEX (Only in PLAY (single) mode)

Displays six images at a time (PLAY (INDEX) mode).

DELETE (Only in PLAY (single) mode)

Setting	Description	PLAY/STILL/MOVIE selector
OK	Deletes the displayed image.	PLAY
CANCEL	Cancels deleting of the image.	

↶ (Return) (Only in PLAY (INDEX) mode)

Returns to PLAY (single) mode.

► Various recording

Setting the image size (IMAGE SIZE)

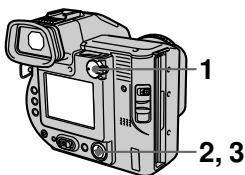

- 1 Set the PLAY/STILL/MOVIE selector to MOVIE or STILL.
- 2 Select [FILE] and then [IMAGE SIZE] from the menu.
- 3 Select the desired image size.

Still image sizes:

1600×1200, 1600 (3:2)*,
1600 (ECM), 1024×768, 640×480

* The image is recorded in the ratio of three to two to fit the printing paper size.

Moving image sizes:

320×240, 160×112

The number of images or the time that you can record on a floppy disk

Image size	Number of images or time*
1600×1200	Approx. 4 (20)
1600 (3:2)	Approx. 4 (20)
1600 (ECM)	Approx. 8 (40)
1024×768	Approx. 10 (52)
640×480	Approx. 30 (159)
320×240	Approx. 15 sec (1 min 25 sec)
160×112	Approx. 60 sec (5 min 45 sec)

Numbers in parentheses indicate the number or time when you use the "Memory Stick" (8 MB) (not supplied).

* When [REC MODE] is set to [NORMAL].

When you select [1600 (ECM)]

The image quality deteriorates, however, the number of images you can record increases. If you give priority to the image quality, select [1600×1200].

Notes

- If you try to record 55 images or more on a floppy disk, even if the remaining disk capacity is sufficient, "DISK FULL" appears on the LCD screen and you cannot record any more images.
- In TEXT mode, even if you select [1600 (ECM)], the number of images you can record is equal with the number in [1600×1200].

Recording still images for e-mail (E-MAIL)

The E-MAIL mode records a small-size (320×240) image at the same time as a still image. Small-size images are convenient for e-mail transmission, etc.

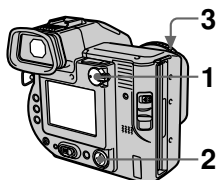

- 1 Set the **PLAY/STILL/MOVIE** selector to **STILL**.
- 2 Select **[FILE]**, **[REC MODE]**, and then **[E-MAIL]** from the menu.
- 3 Record the image.

The number of images that you can record on a floppy disk in **E-MAIL** mode

Image size	Number of images
1600×1200	Approx. 3 (19)
1600 (3:2)	Approx. 3 (19)
1600 (ECM)	Approx. 7 (35)
1024×768	Approx. 8 (47)
640×480	Approx. 22 (120)

Numbers in parentheses indicate the number when you use the “Memory Stick” (8 MB) (not supplied).

To return to normal recording mode

Select **[NORMAL]** in step 2.

Adding audio files to still images (VOICE)

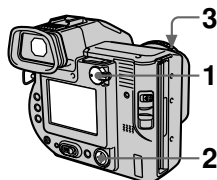

- 1 Set the **PLAY/STILL/MOVIE** selector to **STILL**.
- 2 Select **[FILE]**, **[REC MODE]**, and then **[VOICE]** from the menu.
- 3 Record the image.
If you press and release the **shutter button**, sound is recorded for five seconds.
If you **hold down the shutter button**, sound is recorded until you release the shutter button for up to 40 seconds.

The number of images that you can record on a floppy disk in **VOICE** mode

Image size	Number of images
1600×1200	Approx. 3 (17)
1600 (3:2)	Approx. 3 (17)
1600 (ECM)	Approx. 5 (30)
1024×768	Approx. 6 (37)
640×480	Approx. 12 (74)

Numbers in parentheses indicate the number when you use the “Memory Stick” (8 MB) (not supplied).

To return to normal recording mode

Select **[NORMAL]** in step 2.

Recording text documents (TEXT)

Text is recorded in GIF format to provide a clear image.

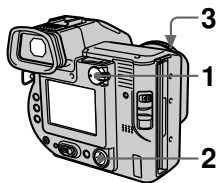

- 1 Set the **PLAY/STILL/MOVIE** selector to **STILL**.
- 2 Select **[FILE]**, **[REC MODE]**, and then **[TEXT]** from the menu.
- 3 Record the image.

The number of images that you can record on a floppy disk in **TEXT** mode

Image size	Number of images
1600×1200	Minimum 4 (25)
1600 (3:2)	Minimum 5 (28)
1600 (ECM)	Minimum 4 (25)
1024×768	Minimum 11 (61)
640×480	Minimum 28 (160)

Numbers in parentheses indicate the number when you use the “Memory Stick” (8 MB) (not supplied).

To return to normal recording mode

Select **[NORMAL]** in step 2.

Notes

- If the subject is not evenly illuminated, you may be unable to record a clear image.
- Writing and reading data take more time than normal recording.

Recording images in macro

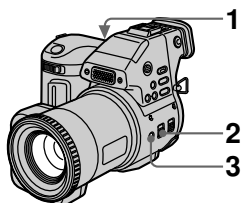

- 1 Set the **PLAY/STILL/MOVIE** selector to **MOVIE** or **STILL**.
- 2 Set the **FOCUS AUTO/MANUAL** switch to **AUTO**.
- 3 Press **⬇** (macro).

The **⬇** (macro) indicator appears on the LCD screen or on the finder. With the zoom lever set to the **W** side, you can shoot a subject that is about 2 cm (13/16 inch) away from the lens surface in macro mode.

To return to normal recording mode

Press **⬇** again. The **⬇** indicator disappears.

Notes

- You cannot record images in macro with the following **PROGRAM AE** modes:
 - Landscape mode
 - Panfocus mode
- You cannot record images in macro if the **⬇** indicator appears.

Focusing manually

Normally the focus is automatically adjusted. The manual focus function is convenient to focus the subject under dark situations.

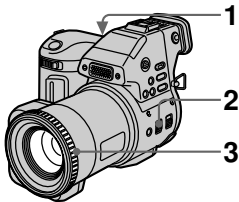

1 Set the PLAY/STILL/MOVIE selector to MOVIE or STILL.

2 Set the FOCUS AUTO/MANUAL switch to MANUAL.

The  (manual focus) indicator appears on the LCD screen or on the finder.

3 Turn the focus ring to achieve a sharp focus.

When you shoot still images, the image on the LCD screen or on the finder is enlarged (double*) and the focal point information appears while the focus is being adjusted. After adjusting, the image returns to normal size. The range is from 2 cm (13/16 inch) to ∞ (infinity).

* When using the digital zoom function, the enlarged image will be less than double size.

To reactivate auto focusing

Set the FOCUS AUTO/MANUAL switch to AUTO.

Notes

- Focal point information may not completely show the correct distance. Use the information as a guide.
- Focal point information does not show the correct distance when attaching the conversion lens.
- If you shoot a subject within 0.8 m (31 1/2 inches) while the zoom lever is set to T side, you cannot get a clear focus. In such cases, the focal point information flashes. Move the zoom lever to the W side until the indicator stops flashing.
- You cannot adjust the focus manually if you have selected the Panfocus mode in the PROGRAM AE function.

Using the PROGRAM AE function

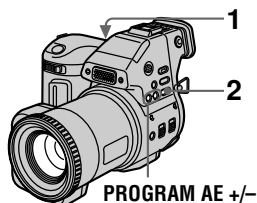

- 1 Set the PLAY/STILL/MOVIE selector to MOVIE or STILL.
- 2 Press PROGRAM AE repeatedly to select the desired PROGRAM AE mode.

AE Aperture priority mode

For making the subject stand out against an unclear background or making both the subject and the background stand out clearly. Press PROGRAM AE +/- repeatedly to select an aperture value in 9 steps from F2.8 to F11.

AE Shutter speed priority mode

For recording a sharp picture of a fast-moving subject or recording the flow of motion of a moving subject. Press PROGRAM AE +/- repeatedly to select a shutter speed in 17 steps from 8" to 1/500 when recording a still image, or in 11 steps from 1/8 to 1/500 when recording a moving image.

Twilight mode

Suppresses the blurring of colors of a bright subject in a dark place so that you can record the subject without losing the dark atmosphere of the surroundings.

Twilight plus mode

Increases the effectiveness of the twilight mode function.

Landscape mode

Focuses only on a distant subject to record landscapes, etc.

Panfocus mode

Changes the focus quickly and simply from a close subject to a distant subject.

To cancel PROGRAM AE

Press PROGRAM AE repeatedly until the indicator on the LCD screen or on the finder goes out.

Notes

- You can focus only on distant subjects in Landscape mode.
- In Panfocus mode, the zoom position is set to the W side and focus is fixed.
- When you record in Twilight plus mode, we recommend that you use a tripod to prevent shaking.
- Set the forced flash **⚡** when you use the flash in the following modes:
 - Twilight mode
 - Twilight plus mode
 - Landscape mode
- You cannot use the PROGRAM AE function when [REC MODE] is set to [TEXT].
- If the setting is not appropriate in aperture priority mode and shutter priority mode, the setting value indicator on the LCD screen or on the finder flashes. In this case, reset the value.

Using the Spot light - metering function

Select this mode when there is backlight or when there is strong contrast between the subject and the background, etc.

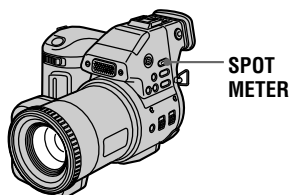

Press SPOT METER to activate the spot light-metering function. Position the point you want to record at the spot light-metering cross hair.

LCD screen/finder

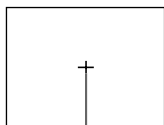

Spot light-metering cross hair

Adjusting the exposure (EXPOSURE)

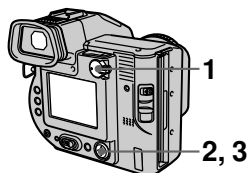

- 1 Set the PLAY/STILL/MOVIE selector to MOVIE or STILL.
- 2 Select [CAMERA] and then [EXPOSURE] from the menu.
- 3 Select the desired exposure value.

Adjust the exposure value while checking the brightness of the background. You can select values ranging from +2.0 EV to -2.0 EV in steps of 1/3 EV.

Note

If a subject is under extremely bright or dark situations, or the flash is used, the exposure adjustment may not be effective.

Adjusting the white balance (WHITE BALANCE)

Normally the white balance is automatically adjusted.

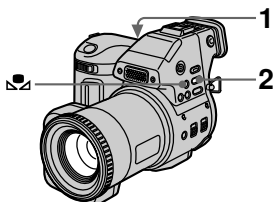

- 1 Set the **PLAY/STILL/MOVIE** selector to **MOVIE** or **STILL**.
- 2 Press **WHITE BALANCE** repeatedly to select the desired white balance setting.

IN DOOR (☀️)

- Places where the lighting condition changes quickly
- Under bright lighting such as photography studios
- Under sodium or mercury lamps

OUT DOOR (🌅)

Recording a sunrise/sunset, night scene, neon signs, or fireworks

One-push white balance (📷)

Adjusting the white balance depending on the light source

AUTO (No indicator)

Adjusts the white balance automatically

② Shoot a white object such as paper full under the same situation you will shoot.

③ Press **📷**.

The **📷** indicator flashes quickly.

When the white balance has been adjusted and stored in the memory, the indicator stops flashing.

To reactivate auto adjustment

Select [AUTO] in step 2.

Notes

- Select [AUTO] when shooting with fluorescent lighting.
- The **📷** indicator means:
 - Slow flashing: white balance is not set.
 - Quick flashing: white balance is being adjusted (after you pressed **📷**).
 - Lit steady: white balance has been set.
- If the **📷** indicator keeps flashing even when you press **📷**, record in automatic white balance mode.

To shoot in one-push white balance mode

① Press **WHITE BALANCE** repeatedly until the **📷** indicator appears.

Recording the date and time on the still image (DATE/TIME)

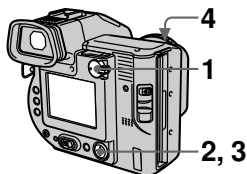

- 1 Set the **PLAY/STILL/MOVIE** selector to **STILL**.
- 2 Select **[EFFECT]** and then **[DATE/TIME]** from the menu.
- 3 Select the date and time.

DAY & TIME

Imposes the date, hour, and minute.

DATE

Imposes the year, month, and day.

OFF

Does not impose the date and time.

- 4 **Record the image.**

The date and time do not appear on the LCD screen or on the finder during shooting, these appear during playback only.

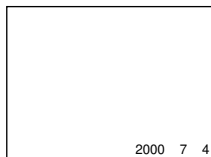

Enjoying picture effects (PICTURE EFFECT)

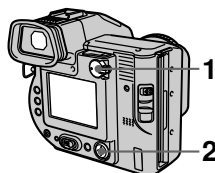

- 1 Set the **PLAY/STILL/MOVIE** selector to **MOVIE** or **STILL**.
- 2 Select **[EFFECT]** and then **[P. EFFECT]** from the menu.

Select the desired mode.

SOLARIZE

The light contrast is clearer and the picture looks like an illustration.

B&W

The picture is monochrome (black and white).

SEPIA

The picture is sepia-toned like an old photograph.

NEG.ART

The color and brightness of the picture are reversed as in a negative.

OFF

Does not use the picture effect function.

To cancel picture effect

Select **[OFF]** in step 2.

► Various playback

Playing back six images at once (INDEX)

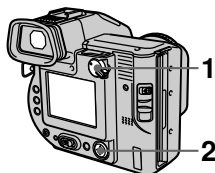



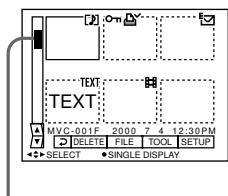

- 1 Set the **PLAY/STILL/MOVIE** selector to **PLAY**.
- 2 Select **[INDEX]** on the LCD screen.

Six images are displayed at once (index screen).





This shows the position of the currently displayed images relative to all the recorded images.

The following marks are displayed on each image according to the image type and settings.

-  : Moving image file
-  : Voice memo file
-  : E-mail file
-  : Print mark
-  : Protect mark
- TEXT: TEXT file
- (No mark): Normal recording (no settings)

To display the next (previous) index screen

Select / at the lower left on the LCD screen or on the finder.

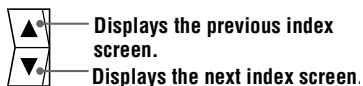

To return to normal playback (single image)

- Select the desired image with the control button.
- Select  (Return).

Note

Images shot in **TEXT** mode cannot be displayed on the **INDEX** screen.

Enlarging a part of the still image (Zoom and trimming)

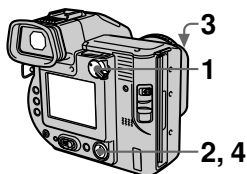

- 1 Set the PLAY/STILL/MOVIE selector to PLAY.**
- 2 Display the image to be enlarged.**
- 3 Zoom in/out the image with the zoom lever.**
The zoom scaling indicator appears on the LCD screen or on the finder.
- 4 Press the control button repeatedly to trim the image.**
 - ▲: The image moves downward
 - ▼: The image moves upward
 - ◀: The image moves rightward
 - ▶: The image moves leftward

To return to the normal size

Zoom out with the zoom lever until the zoom scaling indicator ($\times 1.1$) disappears from the screen, or simply press the center \bullet .

To record an enlarged image (trimming)

- ① Enlarge the image.
- ② Press the shutter button. The image is recorded at 640×480 size and the image on the LCD screen or on the finder returns to the normal size after recording.

Notes

- You cannot use this function on moving images or TEXT mode images.
- Zoom scaling is up to 5× regardless of the original image size.
- The quality of enlarged images may be deteriorated.
- The original data is left even if you enlarge the image.
- The enlarged image is recorded as the newest file.

Playing back the still images in order (SLIDE SHOW)

This function is useful for checking the recorded images or for presentations, etc.

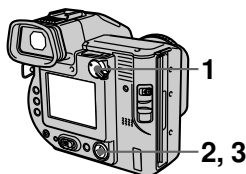

- 1 Set the PLAY/STILL/MOVIE selector to PLAY.**
- 2 Select [FILE] and then [SLIDE SHOW] from the menu.**
Set the following items.

INTERVAL

You can select from 1 min (one minute), 30 sec (30 seconds), 10 sec (10 seconds), 5 sec (5 seconds), or 3 sec (3 seconds).

REPEAT

ON: Plays back images in a continuous loop (approximately 20 minutes) until [RETURN] is selected.

OFF: After all images have been played back, the slide show ends.

- 3 Select [START] with the control button.**
The slide show begins.

To cancel the slide show

Select [CANCEL] in step 2 or 3.

To skip to the next/previous image during the slide show

Select **⏪/⏩** at the lower-left on the screen.

Notes

- The interval setting time may vary depending on the image size.
- When [REPEAT] is set to [ON], the slide show does not end until all the images played back, even if it takes more than 20 minutes.

Viewing images on a TV screen

Before connecting your camera, be sure to turn off the TV.

Set the TV/
VIDEO switch
to "VIDEO."

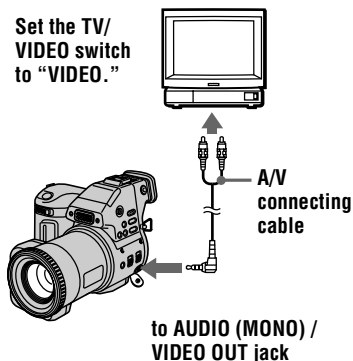

- 1 Connect the A/V connecting cable to the AUDIO (MONO) / VIDEO OUT jack of your camera and to the audio/video input jacks of the TV.**

If your TV has stereo type input jacks, connect the audio plug of the A/V connecting cable to the Lch jack.

- 2 Turn on the TV and start playback on your camera.**
The playback image appears on the TV screen.

Note

You cannot use a TV that has an antenna (aerial) connector only.

► Editing

Preventing accidental erasure (PROTECT)

The  (protect) indicator appears on protected images.

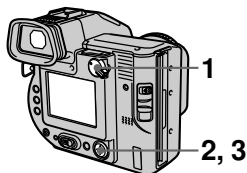

In single mode

- 1 Set the PLAY/STILL/MOVIE selector to PLAY, then display the image to be protected.
- 2 Select [FILE], [PROTECT], and then [ON] from the menu.
The displayed image is protected and the  indicator appears.

To release protection

Select [OFF] in step 2.

In INDEX mode

- 1 Set the PLAY/STILL/MOVIE selector to PLAY, then display the INDEX screen.
- 2 Select [FILE], [PROTECT], and then [ALL] or [SELECT] from the menu.

3 When you select [ALL]

Select [ON].

All the images in the floppy disk are protected.

When you select [SELECT]

Select all the images to be protected with the control button, then select [ENTER]. The selected images are protected.

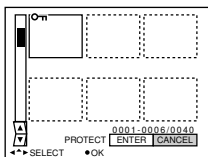

To release protection

If you selected [ALL] in step 2, select [OFF]. If you selected [SELECT] in step 2, select the images to be unprotected with the control button, then select [ENTER].

Deleting images (DELETE)

Protected images cannot be deleted.

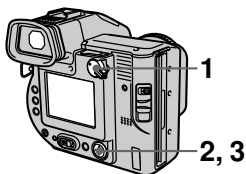

In single mode

- 1 Set the **PLAY/STILL/MOVIE** selector to **PLAY**, then display the image to be deleted.
- 2 Select **[DELETE]** and then **[OK]** from the menu.
The image is deleted.

In INDEX mode

- 1 Set the **PLAY/STILL/MOVIE** selector to **PLAY**, then display the **INDEX** screen.
- 2 Select **[DELETE]** and then **[ALL]** or **[SELECT]** from the menu.

- 3 **When you select [ALL]**
Select **[ENTER]**.
All the unprotected images are deleted.

When you select [SELECT]
Select all the images to be deleted with the control button, then select **[ENTER]**. The  (delete) indicator appears on the selected images and these images are deleted.

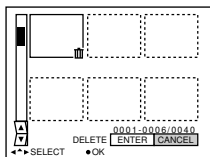

To cancel deleting

Select **[CANCEL]** in step 2 or 3.

Changing the recorded still image size (RESIZE)

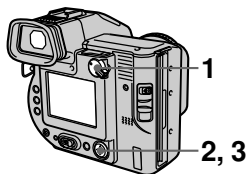

- 1 Set the **PLAY/STILL/MOVIE** selector to **PLAY**, then display the image of which you want to change the size.
- 2 Select **[TOOL]** and then **[RESIZE]** from the menu.
- 3 Select the desired size.
1600×1200, 1024×768, 640×480.
The resized image is recorded and the image on the LCD screen or on the finder returns to the previous size after recording.

To cancel changing the size

Select **[CANCEL]** in step 3.

Notes

- When you change from a small size to a large size, the picture quality deteriorates.
- The original image is retained even after resizing.
- You cannot change the size of images recorded in **TEXT** mode or moving pictures.
- The resized image is recorded as the newest file.

Copying images (COPY)

Copies images to another floppy disk.

In single mode

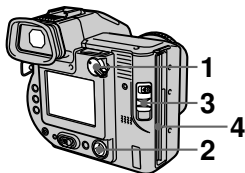

- 1 Set the **PLAY/STILL/MOVIE** selector to **PLAY**, then display the image to be copied.
- 2 Select **[TOOL]**, **[COPY]**, and then **[OK]** from the menu.
“DISK ACCESS” appears.
- 3 When “**CHANGE FLOPPY DISK**” appears, eject the floppy disk.
“INSERT FLOPPY DISK” appears.
- 4 Insert another floppy disk.
“RECORDING” appears. When copying is completed, “COMPLETE” appears.
To end copying, select **[EXIT]**.

To continue copying the image to other floppy disks

After “COMPLETE” appears in step 4, select **[CONTINUE]** and repeat steps 3 and 4 above.

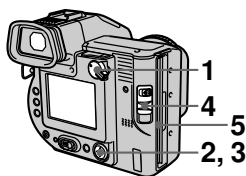

- 1 Set the PLAY/STILL/MOVIE selector to PLAY, then display the INDEX screen.**
- 2 Select [TOOL], [COPY], and then [ALL] or [SELECT] from the menu.**
- 3 When you select [ALL]**
Select [OK].
All the images are copied.
When you select [SELECT]
Select the images to be copied with the control button.
The ✓ mark appears on the images.
Select all the images to be copied, then select [ENTER].
“DISK ACCESS” appears.
- 4 When “CHANGE FLOPPY DISK” appears, eject the floppy disk.**
“INSERT FLOPPY DISK” appears.
- 5 Insert another floppy disk.**
“RECORDING” appears. When copying is completed, “COMPLETE” appears.
To end copying, select [EXIT].

To continue copying the image to other floppy disks

After “COMPLETE” appears in step 5, select [CONTINUE] and repeat steps 4 and 5 above.

To cancel copying part-way

Change the PLAY/STILL/MOVIE selector position or turn off the power.

Note

If you eject and insert the floppy disk without selecting [EXIT] after “COMPLETE” appears, the image will be copied to the floppy disk.

Notes on the Floppy Disk Adaptor for Memory Stick

- You cannot select [ALL] when copying images in the “Memory Stick.”
- You cannot copy images from a floppy disk to a “Memory Stick.”
- When copying from a “Memory Stick” to a floppy disk, the file information (Exif tag) is not copied.

Copying all the information on your floppy disk (DISK COPY)

You can copy to another disk not only the images you have recorded with your camera but also various files you have created in other software with your personal computer.

Notes

- With copying disk, all information saved on the recipient floppy disk is erased to be replaced by newly written data including the protected image data. Check the contents of the recipient disk before copying disk.
- Be sure to use a formatted floppy disk to carry out DISK COPY.

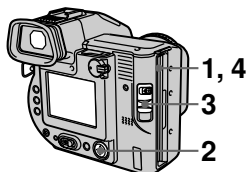

- 1** Insert the floppy disk to be copied.
- 2** Select [FILE], [DISK TOOL], [DISK COPY], and then [OK] from the menu.
“DISK ACCESS” appears.
- 3** When “CHANGE FLOPPY DISK” is displayed, eject the floppy disk.
“INSERT FLOPPY DISK” appears.

- 4** Insert another floppy disk.
“RECORDING” appears. When copying is completed, “COMPLETE” appears.
To end copying, select [EXIT].

To continue copying the image to other floppy disks

After “COMPLETE” appears in step 4, select [CONTINUE] and repeat steps 3 and 4 above.

To cancel copying part-way

Change the PLAY/STILL/MOVIE selector position or turn off the power.

Note

If you eject and insert the floppy disk without selecting [EXIT] after “COMPLETE” appears, DISK COPY will be carried out onto the floppy disk.

Note on the Floppy Disk Adaptor for Memory Stick

You cannot do DISK COPY between “Memory Stick”s and floppy disks.

Selecting still images to print (PRINT MARK)

You can mark a print mark on still images recorded with your camera. This mark is convenient when you have images printed at a shop that conforms with the DPOF (Digital Print Order Format) standard.

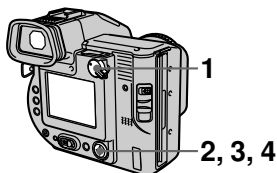

In single mode

- 1 Set the **PLAY/STILL/MOVIE** selector to **PLAY** and display the image you want to print.
- 2 Select **[FILE]**, **[PRINT MARK]**, and then **[ON]** from the menu. The  (print) mark is marked on the displayed image.

To remove the print mark

Select **[OFF]** in step 2.

In INDEX mode

- 1 Set the **PLAY/STILL/MOVIE** selector to **PLAY**, then display the **INDEX** screen.
- 2 Select **[FILE]**, **[PRINT MARK]**, and then **[SELECT]** from the menu.
- 3 Select the images to be marked with the control button.

4 Select **[ENTER]**.

The  marks on the selected images change from green to white.

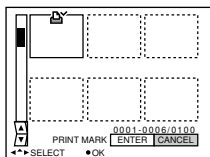

To remove selected print marks

Select the images to be removed in step 3 with the control button, then select **[ENTER]**.

To remove all the print marks

Select **[FILE]**, **[PRINT MARK]**, **[ALL]**, and then **[OFF]** from the menu. The  marks on all images are removed.

To print out using the FVP-1 Mavica Printer

Set **PRESET SELECT SW** to **PC** on the printer.

Note

You cannot mark a print mark on moving images or **TEXT** mode images.

Format

When you format a floppy disk, all data stored on the floppy disk will be deleted. Check the contents of the floppy disk before formatting.

Note

Even if images are protected, these images will be deleted.

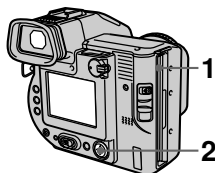

- 1** Insert the floppy disk you want to format.
- 2** Select [FILE], [DISK TOOL], [FORMAT], and then [OK] from the menu.

To cancel formatting

Select [CANCEL] in step 2.

Notes

- When you format the disk, be sure to use a fully charged battery pack or the AC power adaptor as the power source.
- If you use the Floppy Disk Adaptor for Memory Stick, you can format "Memory Stick"s.

Additional information

Precautions

On cleaning

Cleaning the LCD screen or finder

Wipe the screen surface with a cleaning cloth (not supplied) or an LCD cleaning kit (not supplied) to remove fingerprints, dust, etc.

Cleaning the camera surface

Clean the camera surface with a soft cloth slightly moistened with water, then wipe the surface dry. Do not use any type of solvent such as thinner, alcohol or benzene as this may damage the finish or the casing.

After using your camera at the seashore or other dusty locations

Clean your camera carefully. Otherwise, the salty air may corrode the metal fittings or dust may enter the inside of your camera, causing a malfunction.

On floppy disks

To protect data recorded on floppy disks, note the following:

- Avoid storing floppy disks near magnets or magnetic fields such as those of speakers and televisions, permanent erasure of disk data may result.
- Avoid storing floppy disks in areas subject to direct sunlight or sources of high temperature, such as a heating device. Floppy disk warping or damage may result, rendering the disk useless.
- Avoid contact with the disk's surface by opening the disk shutter plate. If the disk's surface becomes blemished, data may be rendered unreadable.

- Avoid getting liquids on the floppy disk.
- Be sure to use a floppy disk case to ensure protection of important data.
- Even when you use a 3.5 inch 2HD floppy disk, image data may not be recorded and/or displayed depending on the using environment. In this case, use an other brand of disks.

On operating temperature

Your camera is designed for use between the temperatures of 0 °C to 40 °C (32 °F to 104 °F). Recording in extremely cold or hot places that exceed this range is not recommended.

On moisture condensation

If the camera is brought directly from a cold to a warm location, or is placed in a very damp room, moisture may condense inside or outside the camera. Should this occur, the camera will not operate properly.

Moisture condensation occurs easily when:

- The camera is brought from a cold location such as a ski slope into a warmly heated room.
- The camera is taken from an air-conditioned room or car interior to the hot outdoors, etc.

How to prevent moisture condensation

When bringing the camera from a cold place to a warm place, seal the camera in a plastic bag and allow it to adapt to conditions at the new location over a period of time (about an hour).

If moisture condensation occurs

Immediately eject the floppy disk, then turn off the camera and wait about an hour for the moisture to evaporate. Note that if you attempt to record with moisture remaining inside the lens, you will be unable to record clear images.

On AC power adaptor

- Unplug the unit from the wall outlet (mains) when you are not using the unit for a long time. To disconnect the power cord (mains lead), pull it out by the plug. Never pull the power cord (mains lead) itself.
- Do not operate the unit with a damaged cord (mains lead) or if the unit has been dropped or damaged.
- Do not bend the power cord (mains lead) forcibly, or place a heavy object on it. This will damage the cord (mains lead) and may cause fire or electrical shock.
- Prevent metallic objects from coming into contact with the metal parts of the connecting section. If this happens, a short may occur and the unit may be damaged.
- Always keep metal contacts clean.
- Do not disassemble the unit.
- Do not apply mechanical shock or drop the unit.
- While the unit is in use, particularly during charging, keep it away from AM receivers and video equipment. AM receivers and video equipment disturb AM reception and video operation.
- The unit becomes warm during use. This is not a malfunction.
- Do not place the unit in locations that are:
 - Extremely hot or cold
 - Dusty or dirty
 - Very humid
 - Vibrating

On battery pack

- Use only the specified charger with the charging function.
- To prevent accident from a short circuit, do not allow metal objects to come into contact with the battery terminals.
- Keep the battery pack away from fire.
- Never expose the battery pack to temperatures above 60 °C (140 °F), such as in a car parked in the sun or under direct sunlight.
- Keep the battery pack dry.
- Do not expose the battery pack to any mechanical shock.
- Do not disassemble nor modify the battery pack.
- Attach the battery pack to the camera securely.
- Charging while some capacity remains does not affect the original battery capacity.

On vanadium-lithium battery

Your camera is supplied with a vanadium-lithium battery installed so as to retain the date and time, etc., regardless of the setting of the POWER switch. The vanadium-lithium battery is always charged as long as you are using your camera. The battery, however, will get discharged gradually if you do not use your camera. It will be completely discharged in about six months if you do not use your camera at all. Even if the vanadium-lithium battery is not charged, it will not affect the camera operation. To retain the date and time, etc., charge the battery if the battery is discharged.

Charging the vanadium-lithium battery:

- Connect your camera to house current (mains) using the AC power adaptor supplied with your camera, and leave your camera with the power turned off for more than 24 hours.
- Or install the fully charged battery pack in your camera, and leave your camera with the power turned off for more than 24 hours.

If any problem occurs, unplug your camera and contact your nearest Sony dealer.

Using your camera abroad

Power sources

You can use your camera in any country or area with the supplied battery charger within 100 V to 240 V AC, 50/60 Hz. Use a commercially available AC plug adaptor **[a]**, if necessary, depending on the design of the wall outlet (mains) **[b]**.

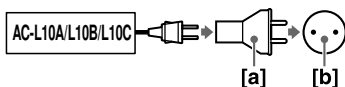

Watching the playback picture on TV

If you want to view the playback picture on a TV, you need a TV having a video input jack and a video connecting cable.

The color system of the TV must be the same as that of your digital still camera. TV color systems differ from country to country. Check the following list:

NTSC system countries

Bahama Islands, Bolivia, Canada, Central America, Chile, Columbia, Ecuador, Jamaica, Japan, Korea, Mexico, Peru, Surinam, Taiwan, the Philippines, the U.S.A., Venezuela, etc.

PAL system countries

Australia, Austria, Belgium, China, Denmark, Finland, Germany, Great Britain, Holland, Hong Kong, Italy, Kuwait, Malaysia, New Zealand, Norway, Portugal, Singapore, Spain, Sweden, Switzerland, Thailand, etc.

PAL-M system country

Brazil

PAL-N system countries

Argentina, Paraguay, Uruguay





SECAM system countries

Bulgaria, Czech Republic, France, Guiana, Hungary, Iran, Iraq, Monaco, Poland, Russia, Slovak Republic, Ukraine, etc.

Troubleshooting

If you experience trouble with your camera, first check the following items. Should your camera still not operate properly after you have made these checks, consult your Sony dealer or local authorized Sony service facility. If code displays (C:□□:□□) appear on the LCD screen or on the finder, the self-diagnosis display function is working (page 63).



Symptom	Cause and/or Solution
Your camera does not work.	<ul style="list-style-type: none">• You are not using an “InfoLITHIUM” battery pack. → Use an “InfoLITHIUM” battery pack (page 8).• The floppy disk is not inserted properly. → Eject the disk, and insert it again (page 14).• The battery level is too low. (The  indicator appears.) → Charge the battery pack (page 9).• The AC power adaptor is not connected securely. → Connect it securely to the DC IN jack and a wall outlet (mains) (page 9, 11).• The malfunction occurs inside the camera. → Turn off the power, and turn on after one minute, then check that the camera works properly.
Your camera cannot record images.	<ul style="list-style-type: none">• The PLAY/STILL/MOVIE selector is set to PLAY. → Set it to MOVIE or STILL (page 15, 21).• No floppy disk has been inserted into your camera. → Insert a floppy disk (page 14).• The tab on the disk is set to the non-recording position. → Set it to the recording position (page 14).
The picture is noisy.	<ul style="list-style-type: none">• Your camera is placed near a TV or other equipment that uses strong magnets. → Move your camera away from the TV, etc.
The picture is too dark.	<ul style="list-style-type: none">• You are shooting a subject with a light source behind the subject. → Adjust the exposure (page 41).• The brightness of the LCD screen is too low. → Adjust the brightness of the LCD screen (page 16).



Symptom	Cause and/or Solution
The flash does not work.	<ul style="list-style-type: none"> • The flash is set to  . → Set the flash to (no indication), , or  (page 19). • The camera is in one of the following PROGRAM AE modes: Twilight, Twilight plus, or Landscape. → Cancel the PROGRAM AE function or set the flash to  (page 19, 40). • The PLAY/STILL/MOVIE selector is set to MOVIE. → Set it to STILL. • The flash is not popped up. → Pop up the flash (page 19).
The read/write time is slow when using a "Memory Stick."	<ul style="list-style-type: none"> • When using the Floppy Disk Adaptor for Memory Stick, writing and reading images take about twice times than using a floppy disk. → This is not a malfunction.
The date and time are recorded incorrectly.	<ul style="list-style-type: none"> • The date and time are not set correctly. → Set the correct date and time (page 12).
Vertical streaks appear when you are shooting a very bright subject.	<ul style="list-style-type: none"> • This is called the smear phenomenon. → This is not a malfunction.
The battery life is short.	<ul style="list-style-type: none"> • You are recording/playing back images under extremely cold temperatures. • The battery pack is not charged enough. → Charge the battery pack fully. • The battery pack is dead. → Replace the battery pack with a new one.
The indication of the battery remaining time is not proper.	<ul style="list-style-type: none"> • You are using the camera for many hours under extremely hot or cold temperatures. • The battery pack is dead. → Replace the battery pack with a new one (page 8). • The battery level is too low. → Install the charged battery pack (page 8, 9).
The power is immediately turned off even if the battery remaining indicator indicates that the battery level is sufficient.	<ul style="list-style-type: none"> → Charge the battery pack about one hour after the normal charge is complete (page 9).
The zoom does not work.	<ul style="list-style-type: none"> • PROGRAM AE is set to the Panfocus mode. → Cancel the Panfocus mode (page 40).

Symptom	Cause and/or Solution
Digital zoom does not function.	<ul style="list-style-type: none"> You cannot use digital zoom to record moving pictures.
The image is in monochrome.	<ul style="list-style-type: none"> You shot the image in TEXT mode. → Cancel the TEXT mode (page 38).
The image and sound break off when you play back an image on a personal computer.	<ul style="list-style-type: none"> You are playing back the file from the floppy disk. → Copy the file to the hard disk of the personal computer and then play back the file from the hard disk (page 26).
The image cannot be played back on a personal computer.	<ul style="list-style-type: none"> → Consult the personal computer or software manufacturer.
Your camera cannot delete an image.	<ul style="list-style-type: none"> The image is protected. → Cancel the protection (page 48).
The power turns off suddenly.	<ul style="list-style-type: none"> With the PLAY/STILL/MOVIE selector set to STILL or MOVIE, if you do not operate the camera for about three minutes while the power is on, the camera turns off automatically to prevent wearing down the battery pack. → Turn on the camera. The battery pack is discharged. → Replace it with a charged battery pack.
The image does not appear on the TV screen.	<ul style="list-style-type: none"> The VIDEO OUT setting of your camera is incorrect. → Change the setting (page 34).
The slide show function stops automatically.	<ul style="list-style-type: none"> The slide show function stops after about 20 minutes. → To continue the slide show, select [START] again (page 46).
You cannot use the PROGRAM AE function.	<ul style="list-style-type: none"> The camera is set to TEXT mode. → Cancel the TEXT mode (page 38).
The  button does not work.	<ul style="list-style-type: none"> The camera is in manual focus mode. → Set it to auto focus mode (page 39). PROGRAM AE is set to the Panfocus mode. → Cancel the Panfocus mode (page 40).
You cannot resize the image.	<ul style="list-style-type: none"> This function does not work on a moving image nor on a TEXT image.
You cannot mark an image with the print mark.	<ul style="list-style-type: none"> The print mark cannot be marked on a moving image nor on a TEXT image.

Warning and notice messages

Various messages appear on the LCD screen. Check the corresponding descriptions in the following list.

Message	Meaning
DRIVE ERROR	There is trouble with the disk drive.
NO DISK	No disk has been inserted.
FORMAT ERROR	<ul style="list-style-type: none">• The floppy disk loaded is not MS-DOS formatted (512 bytes×18 sectors).• The battery level of the Floppy Disk Adaptor for Memory Stick is low.
DISK PROTECT	The tab on the disk is set to the non-recording position.
DISK FULL	The disk is full.
NO FILE	No image has been recorded on the disk.
FILE ERROR	Trouble has occurred during playback.
FILE PROTECT	The image is protected.
DISK ERROR	A 2DD floppy disk is inserted, or there is trouble with the disk.
NOT ENOUGH MEMORY	The remaining capacity of the floppy disk is not enough to copy the image.
IMAGE SIZE OVER	You tried to play back images with an image size larger than the maximum playback size of this camera.
INVALID OPERATION	<ul style="list-style-type: none">• You cannot do DISK COPY between a “Memory Stick” and a floppy disk.• You select [ALL] from [COPY] when copying images in the “Memory Stick.”
for "InfoLITHIUM" battery only	The battery is not the “InfoLITHIUM” type.
	The image is protected.
	The battery level is too low.
NOT ENOUGH FD ADAPTOR'S BATTERY	The battery level of the Floppy Disk Adaptor for Memory Stick is low.
 COULDN'T RECORD	The battery level of the Floppy Disk Adaptor for Memory Stick is too low to shoot.

Message	Meaning
 INVALID OPERATION	The battery level of the Floppy Disk Adaptor for Memory Stick is too low to do some operations.
 DISK ERROR	<ul style="list-style-type: none">• The battery level of the Floppy Disk Adaptor for Memory Stick is too low to operate.• Trouble has occurred on the Floppy Disk Adaptor for Memory Stick.

Self-diagnosis display

Your camera has a self-diagnosis display. This function displays the camera condition on the LCD screen or on the finder with a combination of a letter and four digits of numbers. If this appears, check the following code chart. The code informs you of the camera's current condition. The last two digits (indicated by □□) will differ depending on the state of the camera.

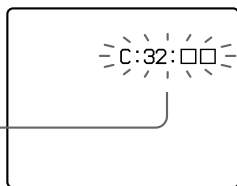

Self-diagnosis display

- C: □□: □□

You can repair the camera yourself.

- E: □□: □□

Contact your Sony dealer or local authorized Sony service facility.

Code	Cause and/or Corrective Action
C:32:□□	<ul style="list-style-type: none"> • There is trouble with the disk drive. → Turn the power off and on again.
C:13:□□	<ul style="list-style-type: none"> • An unformatted floppy disk is inserted. → Format the floppy disk. (page 54) • An disk not compatible with this camera is inserted. → Change the disk. (page 14) • The battery level of the Floppy Disk Adaptor for Memory Stick is too low. → Replace the battery with a new one.
E:61:□□ E:91:□□	<ul style="list-style-type: none"> • A camera malfunction that you cannot repair has occurred. → Contact your Sony dealer or local authorized Sony service facility and inform them of the 5-digit service code. (example: E:61:10)

If you are unable to rectify the problem even if you try corrective actions a few times, contact your Sony dealer or local authorized Sony service facility.

Specifications

System

Image device

1/2.7 type color CCD

Lens

10x zoom lens

f = 6.0 – 60.0 mm (1/4 – 2 3/8 inches) (39 – 390 mm (1 9/16 – 15 3/8 in) when converted into a 35 mm still camera)

F = 2.8

Exposure control

Automatic exposure

White balance

Automatic, Indoor, Outdoor, One-push

Data compression system

Movie: MPEG1

Still:

Floppy disk: JPEG (JFIF)

“Memory Stick”: JPEG (Exif2.1)

GIF (in TEXT mode)

Audio (with still image): MPEG AUDIO (Monaural)

Recording medium

Floppy disk:

3.5 inch 2HD MS-DOS format (1.44MB)

MSAC-FD2M Floppy Disk Adaptor for Memory Stick: DCF98 format

Flash

Recommended recording distance:

0.6 m to 2.5 m (23 5/8 in to 8 1/3 feet)

Input and Output connector

AUDIO (MONO) /VIDEO OUT (Monaural)

Mini-jack Video:

1 Vp-p, 75 Ω unbalanced, sync negative

Audio: 327 mV (at a 47 k Ω load)

Output impedance: 2.2 k Ω

External flash jack

Mini-jack

LCD screen

Used LCD panel

TFT (Thin Film Transistor active matrix) drive

Total number of dots

123 200 (560x220) dots

Finder

Used LCD panel

TFT (Thin Film Transistor active matrix) drive

Total number of dots

180 000 (800x225) dots

General

Application

Sony battery pack NP-F330 (supplied)/F550

Power requirements

8.4 V

Power consumption (During shooting)

3.9 W (When using the LCD screen)

3.5 W (When using the finder)

Operation temperature

0°C to 40°C (32°F to 104°F)

Storage temperature

-20°C to +60°C (-4°F to +140°F)

Maximum dimensions

126x124x184 mm (5x5x 7 1/4 in) (w/h/d)

Mass

Approx. 970 g (2 lb 2 oz) (including battery, floppy disk and lens cap, etc.)

Built-in microphone

Electret condenser microphone

Built-in speaker

Dynamic speaker

AC-L10A/L10B/L10C

AC power adaptor

Power requirements

100 V to 240 V AC, 50/60 Hz

Rated output voltage

DC 8.4 V, 1.5 A in operating mode

Operation temperature

0°C to 40°C (32°F to 104°F)

Storage temperature

-20°C to +60°C (-4°F to +140°F)

Maximum dimensions

125x39x62 mm (5x1 9/16x 2 1/2 inches) (w/h/d)

Mass

Approx. 280 g (10 oz)

NP-F330 battery pack

Used battery

Lithium ion battery

Maximum voltage

DC 8.4 V

Nominal voltage

DC 7.2 V

Capacity

5.0 Wh (700 mAh)

Accessories

AC-L10A/L10B/L10C AC power adaptor (1)

Power cord (mains lead) (1)

NP-F330 battery pack (1)

A/V connecting cable (1)

Shoulder strap (1)

Lens cap (1)

Lens cap strap (1)

CD-ROM (1)

Operating instructions (1)

Design and specifications are subject to change without notice.

LCD screen/finder indicators

The indicators during recording

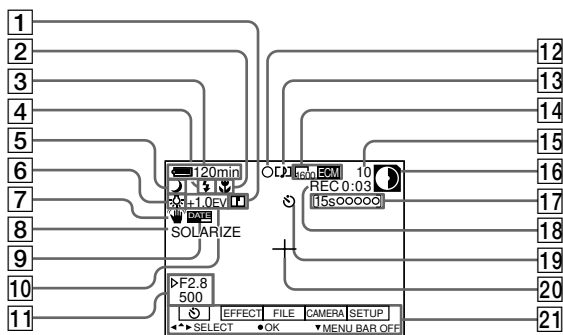

- 1 Sharpness indicator
- 2 Focus mode indicator/Macro indicator
- 3 Battery remaining indicator
- 4 Flash level indicator/Flash mode indicator
- 5 PROGRAM AE indicator/Zoom indicator
- 6 White balance indicator
- 7 SteadyShot indicator
- 8 Picture effect indicator
- 9 Date and time indicator
- 10 EV level indicator
- 11 Iris/Shutter speed indicator
- 12 AE lock indicator/Focus lock indicator
- 13 Recording mode indicator
- 14 Image size indicator
- 15 Number of recorded images
- 16 Remaining disk capacity indicator
- 17 Recording time indicator
- 18 Self-diagnosis function indicator/Recording time indicator
- 19 Self-timer indicator
- 20 Spot light-metering indicator
- 21 Menu bar and guide menu
They appear by pressing ▲ on the control button and disappear by pressing ▼.

The indicators during still image playback

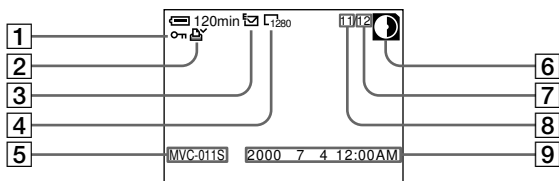

- | | |
|--|--|
| <ul style="list-style-type: none"> 1 Protect indicator/Zoom scaling indicator 2 Print mark indicator 3 Recording mode indicator 4 Image size indicator 5 File name* | <ul style="list-style-type: none"> 6 Remaining disk capacity indicator 7 Number of stored images on a floppy disk 8 Image number 9 Recording date of the playback image* |
|--|--|

* When the menu bar is displayed, this indicator disappears from the screen.

The indicators during moving image playback

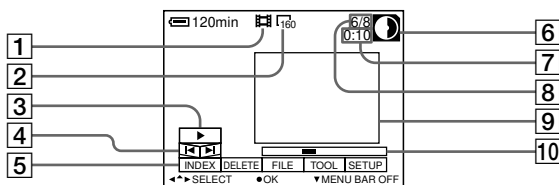

- | | |
|--|--|
| <ul style="list-style-type: none"> 1 Moving image file indicator 2 Image size indicator 3 Playback button
▶ is displayed during stop, and during playback. 4 Image searching buttons 5 Menu bar and guide menu 6 Remaining disk capacity indicator 7 Counter | <ul style="list-style-type: none"> 8 Image number/number of stored images on a floppy disk 9 Playback image 10 Playback bar |
|--|--|

Index

Symbols

“InfoLITHIUM” battery pack8

A

AC power adaptor.....11
Adjusting brightness
 Image.....41
 LCD screen.....16
AE (auto exposure).....15
Auto power-off function..9

B

Battery pack
 Charging.....9
 Installing.....8
 Remaining time.....9
 Usable time.....10
BEEP.....35

C

Charging.....9
Cleaning.....55
CLOCK SET.....12
Control button.....29

D

DELETE.....49
DEMO.....34
DIGITAL ZOOM.....34
DISK COPY.....52
DPOF.....53

E

Editing
 COPY.....50
 DELETE.....49
 PROTECT.....48
E-MAIL.....37

F

FILE NUMBER.....32
Finder.....16
FLASH LEVEL.....34
Floppy disk
 Copying.....52
 Format.....54
 Inserting.....14
 Number of recordable
 images
 36, 37, 38
 Usable type.....14
FORMAT.....54
Full charge.....9

I

Image
 Copying.....50
 Deleting.....49
 File name.....27
 Print mark.....53
 Protect.....48
 Size.....36
INDEX screen.....44
Indicators on the LCD
 screen.....65

J

JPEG.....15, 25

M

Macro recording.....38
Manual focusing.....39
Menu.....31
Moisture condensation..55
Moving image
 Playback.....23
 Recording.....21
MPEG.....21, 25

N

Normal charge.....9
Number of recordable
 images
 Battery pack.....10
 E-mail mode.....37
 Image size.....36
 TEXT mode.....38
 Voice mode.....37

P

PICTURE EFFECT.....43
PLAY/STILL/MOVIE
 selector.....29
Playing back
 INDEX screen.....44
 Moving images.....23
 Slide show.....46
 Still images.....22
 Viewing images on a
 TV.....47
 Viewing images using a
 personal computer
 25

Power source

 AC power adaptor.....11
 Battery pack.....8
PRINT MARK.....53
PROGRAM AE.....40
PROTECT.....48

R

REC MODE.....33

Recording

 E-mail mode.....37
 In macro.....38
 Moving image.....21
 Still image.....15
 TEXT mode.....38
 Voice memo.....37
 With flash.....19
RESIZE.....50

S

Self timer.....19
Self-diagnosis display...63
Setting the date and time
 12
Single display.....44
SLIDE SHOW.....46
SteadyShot.....18
Still image
 Playback.....22
 Recording.....15

T

TEXT mode.....38

U

Using flash.....19
Using your camera abroad
 57

V

Viewing images using a
 personal computer.....25
VOICE.....37

W

Warning messages.....61
White balance.....42

Z

Zoom.....17

Sony  line

<http://www.world.sony.com/>

Printed on recycled paper

Printed using vegetable oil ink with less than 1% VOC (Volatile Organic Compound).
